



Lateral Lifting Clamp

(Lock Handle type)

HLC-H
HLC-WH

Operation Manual

This operation manual explains the basic operation and handling of the clamps. Please read this manual carefully before use and observe the precautions for safe operation.

SUPER TOOL CO., LTD.



SUPER brand lifting clamps are energy-saving lifting equipment which have been developed for the purpose of transporting steel materials.

Proper use

Operate lifting clamps after carefully reading and understanding this instruction manual for enhancing efficiency and safety of operation.

Prime efficiency and economy

Advanced functions, reasonableness and versatile applications of finely and carefully designed  lifting clamps ensure prime efficiency and economy.

Special considerations on safety

We conduct a pulling test with a load three times (or twice) of rated capacity and a manufacturing serial number is marked on each product, thus directing a special attention to safety.

Precautions for safety operation

(Pages 1~10 are comon to all lifting clamp models)

Be sure to read this instruction manual carefully before use.

Mistaken use of lifting clamp may cause a danger such as dropping of load.

Education of “crane safety regulations,” “operation manual for lifting clamp,” “your company’s operation standards,” etc. should be given before actual operation not only to business owners who have purchased clamps but also to their operators to ensure that actual operators have acquired enough knowledge, safety information, and precautions of the clamps.

Safety precautions are divided into two classifications in this manual; “Warning” and “Caution,”.



WARNING:

Indicates a potentially hazardous situation which, if not avoided, could result in death or serious injury.





CAUTION:

Indicates a potentially hazardous situation which, if not avoided, could result in medium damage or slight injury, or could result in property damage.

While only mentioned in  CAUTION, failure to comply with them still may lead to a serious disaster. As such, do not fail to pay attention both to WARNING and CAUTION which are of great importance.

Meanings of Signs

The signs of  and  indicate that precautions should be taken.

The contents of warning or caution are described at each sign.



The sign of  indicates prohibited actions.

The sign of  indicates that an action is enforced or instructed.







Two point lift for  righthand figure.

※ After reading this manual, make sure to keep it at a place of easy access by any users.







1. Handling in general

 WARNING	
<ul style="list-style-type: none"> ● Do not operate until the contents of the operation manual, and caution tag/plate are thoroughly read and understood. ● Do not operate without a legal qualification. ● Be sure to clear of the area of the operation for lifting or turning a load against possible drop off or fall over. ● Do not use for other than intended purpose. 	 Prohibited
<ul style="list-style-type: none"> ● Make sure to execute an inspection periodically and before each operation. 	 Instructed



2. Check before operation





 WARNING	
<ul style="list-style-type: none"> ● Do not use clamp unsuitable for the operation method. ● Do not use clamp of an abnormal condition; deformed, cracked, worn, malfunctioning, etc. ● If the load is under the following conditions, do not use clamp. (A material of fragile, high-hardness, low-hardness or extremely low-hardness, or a member with the gripping part tapered down more than 8°) 	 Prohibited
<ul style="list-style-type: none"> ● Check the type, rated capacity, clamp range, and “periodic inspection completed” label displayed on clamp body. ● The load to be lifted shall be within an allowable range of rated capacity of clamp. ● Thickness of load shall be within designated clamping range. 	 Instructed
 CAUTION	
<ul style="list-style-type: none"> ● Do not use clamp for the load under the following conditions. (Load to be lifted is more than 150°C, or in an atmosphere or solution of acid or alkaline chemicals less than minus 20°C) 	 Prohibited
<ul style="list-style-type: none"> ● Sling to be used for the clamp shall be an appropriate one for lifting operation. 	 Instructed

3. Lifting operation





 WARNING	
<ul style="list-style-type: none"> ● Do not use clamp, lifting at one point. (excluding special or custom ordered products) ● Do not use the clamp in the following ways of lifting: lifting of two or more individual objects at one time. (overlapped loads, padded load etc. , or side gripping) ● Do not use the clamp for pulling out steel plate sheet from the steel sheet pile or for vertical lifting of the sheet. ● Do not use the clamp when strong wind may threaten to cause any danger. ● Do not use the clamp for a hydraulic shovel. 	 Prohibited
<ul style="list-style-type: none"> ● Install two or more clamps in a balanced way to keep the balance of load. 	 Two point lift
<ul style="list-style-type: none"> ● The lifting angle of the clamps and the dividing angle should be kept within the allowable angles according to types. Load should be inserted to the innermost end of the jaw opening. ● When you use the clamp with a lock mechanism, never fail to have the lock engaged. 	 Instructed
 CAUTION	
<ul style="list-style-type: none"> ● If oil, paint, scale, rust, etc. are on the gripping pad, do not use the clamp. ● Do not drop clamp or drag on the ground. 	 Prohibited

4. Operation of a crane

 WARNING	
<ul style="list-style-type: none"> ● Never lift a load exceeding the rated capacity. ● Do not operate a crane in such a way as to give an impact to the load or the clamp. ● Do not allow a person to stand on the load or to carry him. ● Do not lift a load which is not free from any other objects. ● Do not release the lock of clamp while lifting load. ● Avoid unintended contact by load to an adjacent member or to the clamp, which has been removed from the load. 	 Prohibited

<ul style="list-style-type: none"> ● Stop the lifting operation by crane for a moment when the load is applied to the lifting ring for safety checking. (depth of the load into the clamp opening; status of locking). ● Stop the operation of the crane just before the load reaches the ground, and check the following matters: (Inclination or falling over of the load and security around the landing area of the load) 	 Instructed
 CAUTION	
<ul style="list-style-type: none"> ● Do not operate the crane in such a way as to drag the load along the ground. ● Do not leave the crane (or winder, etc.) unattended from an operating position while keeping the load lifted with the clamp. 	 Prohibited
<ul style="list-style-type: none"> ● Raising and lowering operation by crane should be done slowly and carefully. 	 Instructed

5. Maintenance, storage and alteration

 WARNING	
<ul style="list-style-type: none"> ● Never alter the clamp and its accessories. ● Do not apply welding or heat to the clamp or its accessories. ● Do not use any other parts than our company's genuine parts. ● Clamps which require the repair should be stored at a different place so that they are not used mistakenly. 	 Prohibited
<ul style="list-style-type: none"> ● Persons with specialized knowledge designated by the business owner are to conduct maintenance and repairing work. ● When any abnormality with the clamp is found, do not use it and immediately repair or dispose. ● Remove, if any, paint or mud sticking to the moving parts of the clamp, cams, and pads. 	 Instructed
 CAUTION	
<ul style="list-style-type: none"> ● Conduct maintenance and repairing without any load attached. ● Conduct maintenance and repairing after posting a sign indicating that you're on the maintenance work. ● Never fail to lubricate oil on the rotating parts of the clamp (around the pins), guide grooves, sliding parts, etc. ● Be sure to store clamps indoor. 	 Instructed

■ General warning for use (common to all lifting clamp models)

1. **Be sure to select proper model clamps for use.**
Pay special attentions to keep the lifting direction (rope angle).
2. Confirm the weight of the load. Do not exceed maximum capacity (designated ton) on clamps. (Never overload.)
3. Before use, confirm followings:
 - (a) Proper capacity of clamps.
 - (b) No abnormal movements of clamp or loosening of any bolts.
 - (c) No oil or other foreign matters on the surface of the cam and pad.
4. **Never use for load beyond the clamp range.**
5. When installing clamps, insert a lifting load completely until it comes in contact with the deepest of the jaw opening of main body.
6. **Depending on the model or capacity of the clamp, the cam teeth may not bite a load sufficiently when the load is a hard or light weight material (Less than 1/5 of maximum capacity or less than 1/4 of maximum clamp range). Confirm the condition of clamp for safety.**
7. Confirm that the safety lock is completely engaged in case clamp has a built-in lock.
8. Confirm that the load is well balanced. Determine the clamp position or the center of gravity of the rope properly. It is especially important to determine the horizontal center of gravity.
9. When lifting at 2 points, be sure to use two wire ropes, and make them equal length. (Fig. A)

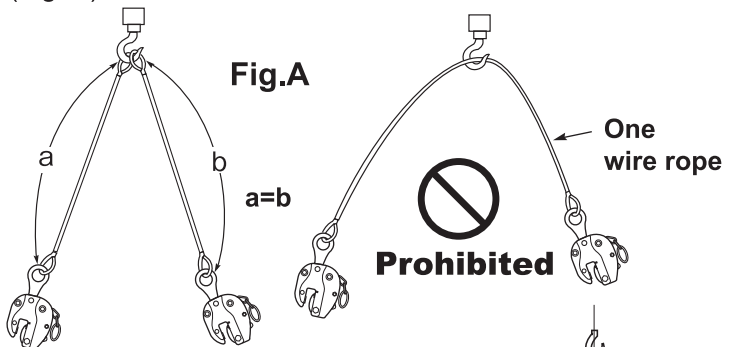

10. When lifting at 2 points, keep the lifting angle within 60°. (Fig. B)

(Follow the standards if lifting angle is specified depending on items.) If the load is long, use a balance.

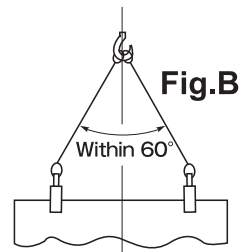

11. Never lift two or more steel plates or steel members at a time.
12. The load may move to an unexpected direction when lifted off the ground and as such confirm the center of gravity and the clamping position for safety when raising. Sufficient caution should be taken until the clamp with the load becomes completely balanced.
13. When changing directions of the load or any similar operations, all personnel must be clear of the area of operation. (Fig. C)

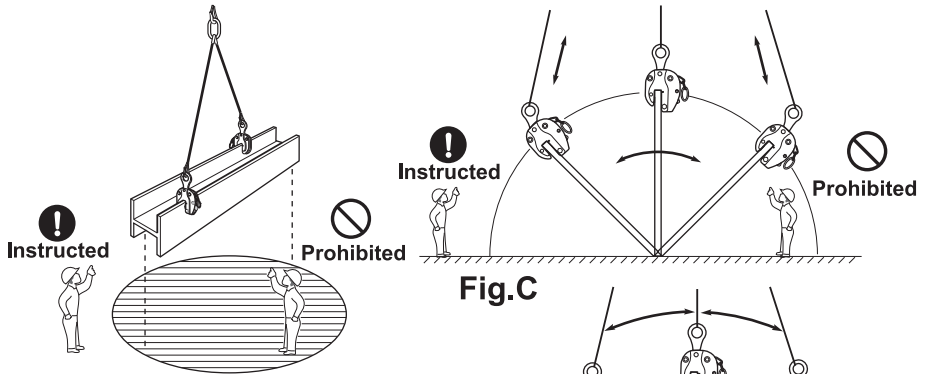

Fig.C

14. Do not ride on the lifting load.
Never use clamp for riding or carrying person.
15. Keep momentary inverting angle of a steel plate within 30°. (Fig. D)

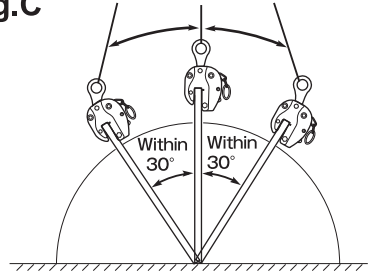

Fig.D

16. **Before operation, the surface of load must always be clean and free of scale, coatings or other foreign matters that will reduce clamping force significantly.**
17. **When raising, special attention must be given to prevent the rope from loosening by its unintended contact with any other objects.**
18. When raising again after the load is put on ground, reconfirm the clamp condition.
19. Do not use clamp for heated load or in a corrosion liquid because safety factor and durability will be reduced in such conditions.
20. Do not alter clamp by welding, cutting by gas or by any other modification.
21. Do not weld electrically a load while being lifted by clamp.
22. Conduct daily maintenance and lubrication.

■ Maintenance and Inspection

1. Maintenance

Daily maintenance is important for efficient and safe operation even under the severe use condition and for such purposes, please comply with the followings.

- (1) Designate the use standards and control.
- (2) Keep clamps indoor and do not leave them outdoor.
- (3) Check the followings to maintain in a good condition.
 - (a) Operating condition.
 - (b) Any abrasion, damage, or clogging at teeth of cam and pad.
 - (c) Deformation of main body - at jaw opening in particular.
- (4) Separate conforming clamps and other hazardous items identified during use or inspection and designate the defective sections. Perform maintenance any soon.
- (5) For the storage, place soft material as wooden chip in-between cam and pad to protect the teeth.
- (6) Perform inspection and maintenance once a week by referring to "Inspection Standards". Lubricate sliding sections periodically. (However, remove oil at teeth of cam and pad.)

2. Periodic Inspection

Perform periodic inspection in accordance with the periodic inspection and maintenance standards. Functions and life of clamps may differ in a great degree as they are used in varieties of fields under different conditions of use. Therefore, preparation and practice of effective handling/inspection standards manual by users themselves are recommended. We ask you to establish complete maintenance and control for assurance of safety in reference to our Manufacturer's Inspection Standards of our clamp. Clamp is designed for easy replacement of parts and therefore, do not fail to replace defective parts. Also, keeping spare parts at all times is recommended. For your preparation of the standards, pay special attention to the followings.

- (1) Operation and maintenance standards
 - (a) Preparation of use criteria (shape of load and operating methods).
 - (b) Thorough understanding and compliance of cautions on handling.
 - (c) Maintenance and storage.
 - (d) Rules of inspection and check at site.

- (2) Standards on periodic inspection
 - (A) Establishing dates of periodic inspection.
 - (B) Establishing inspection and maintenance methods.
 - (a) Inspecting period.
 - (b) Person in charge of the inspection.
 - (c) Inspection site.
 - (d) Tools and devices for inspection.
 - (e) Establishment of permissible limit of use.
 - (f) Explicit designation of maintenance and repair methods.

3. Manufacturer's inspection method

Our company's inspection procedures are as follow.

Check for

- (1) Movements.
- (2) Wear, loss, and/or clogging of/at the teeth of the cam and screw.
- (3) Deformation of main body.
- (4) Deformation of shackle.
- (5) The status of bolts, pins, links and springs.
- (6) Deep scratches in general.
- (7) Other checking items based on the Standards.

LIFTING ANGLE AND SAFE LOAD OF WIRE ROPE

The maximum allowable load (safe load) of wire rope also varies with the lifting angle. Therefore, select a wire rope of proper diameter in consideration of the lifting angle. (The breakage load specified in table below refers to No.4. 6×24A class of JIS G3525.)

Correlation between Lifting Angle and Safe Load of Wire Rope (in two-point lifting)

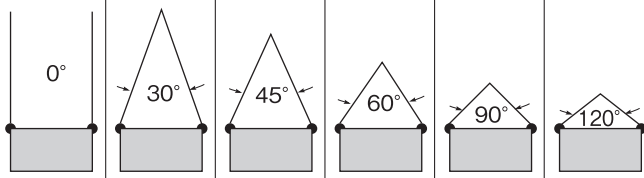
D Wire rope dia (mm)	σ Breakage load (tons)	W Safe load (on one rope) W=σ/S (safety factor S=6) (tons)						
			(Changes in lifting efficiency due to lifting angle.%)					
			100%	96%	92%	86%	70%	50%
			Max.allowable load (safe load) on two wire ropes (tons)					
8	3.21	0.54	1.08	1.04	0.99	0.93	0.76	0.54
9	4.06	0.68	1.36	1.31	1.25	1.17	0.95	0.68
10	5.02	0.84	1.68	1.61	1.55	1.44	1.18	0.84
11.2	6.29	1.05	2.1	2.02	1.93	1.81	1.47	1.05
12.5	7.84	1.31	2.62	2.52	2.41	2.25	1.83	1.31
14	9.83	1.64	3.28	3.15	3.02	2.82	2.3	1.64
16	12.8	2.13	4.26	4.09	3.92	3.66	2.98	2.13
18	16.2	2.7	5.4	5.18	4.97	4.64	3.78	2.7
20	20.1	3.35	6.7	6.43	6.16	5.76	4.69	3.35
22.4	25.2	4.2	8.4	8.06	7.73	7.22	5.88	4.2
25	31.3	5.22	10.44	10.02	9.6	8.98	7.31	5.22
28	39.3	6.55	13.1	12.58	12.05	11.27	9.17	6.55
30	45.1	7.52	15.04	14.44	13.84	12.93	10.53	7.52
31.5	49.8	8.3	16.6	15.94	15.27	14.28	11.62	8.3
33.5	56.3	9.38	18.76	18.01	17.26	16.13	13.13	9.38
35.5	63.2	10.53	21.06	20.22	19.38	18.11	14.74	10.53

Note For four-point lifting, multiply the corresponding figure in the table by 2 to find the maximum allowable load (safe load).

Simplified calculation method of wire rope diameter and safe load(one-point lifting)

1) $D = \sqrt{W \times C}$

2) $W = \frac{D^2}{C}$

Where D: wire rope diameter(mm)
W: safe load(tons)
C : constant=120
(safety factor S=6)

★To find the diameter of wire rope for 3 tons:

① $D = \sqrt{W \times C}$

$D = \sqrt{3 \times 120} = \sqrt{360} = 19 \rightarrow 20\text{mm}$

★To find the service load (safe load) on 25mm diameter wire rope.

② $W = \frac{D^2}{C}$

$W = \frac{25^2}{120} = \frac{625}{120} = 5.2 \rightarrow 5.2\text{ton}$



Lateral Lifting Clamp

(Lock Handle type)

HLC-H
HLC-WH

Operation Manual and Inspection Standards



Lateral Lifting Clamp

(Lock Handle type)

HLC-H

HLC-WH

■ Uses

Clamps specifically designed for lateral (horizontal) lifting of steel beams for structure (H beam, I beam, T beam, L beam, etc.) and flat steel bars.

■ Features

1. Clamps are elaborately designed for stable lifting of the “H”, “I” shaped steel and steel plate.
2. By setting U-handle (Lock handle), clamping force is constantly given by a spring built into the body, and the load is hardly detached even when the load lands and wire gets loosen.
3. The handle makes it easy and safe to set and remove the clamp onto and from the load.

■ Specifications

Item No.	Rated Capacity (ton)	Clamp Range (mm)	Net Weight (kg)
HLC 0.5H	0.5	0~25	3.0
HLC 1H	1	0~30	5.5
HLC 1WH	1	0~40	5.9
HLC 2H	2	0~35	9.5
HLC 3H	3	0~40	13.5
HLC 3WH	3	25~60	19.0
HLC 5H	5	0~45	23.0
HLC 5WH	5	25~65	29.0
HLC 7H	7	10~70	50.0
HLC 7WH	7	30~90	52.0
HLC 10H	10	20~80	70.0
HLC 10WH	10	40~100	72.0

REPLACEMENT PARTS AND ASSEMBLIES HLC0.5~3H

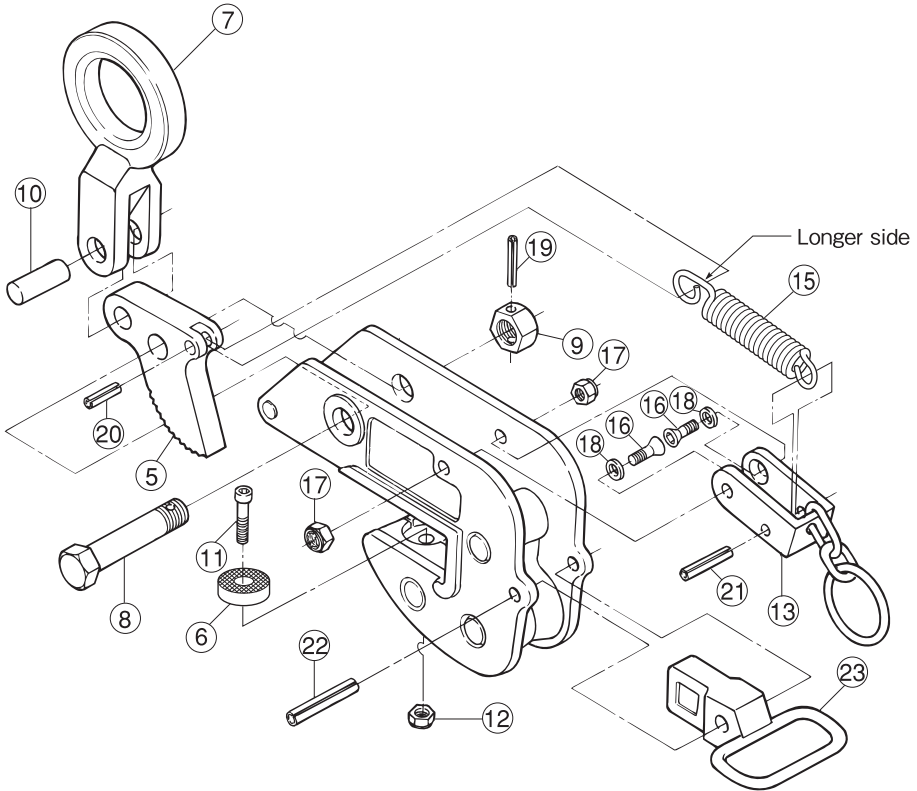

Part No.	Part Name	Item No.	Set Q'ty	Part No.	Part Name	Item No.	Set Q'ty
SHACKLE ASSEMBLY				HANDLE			
7	Shackle	HLCH	1	13	U shaped handle	HLCU	1
10	Connection pin	HLCY	1	21	Spring pin	HLCQ	1
Cam				16	Hex. hole bolt	HLCK	2
5	Cam	HLCT	1	17	U shaped nut	HLCK	2
20	Spring pin	HLCR	1	18	Collar	HLCC	2
8	Support bolt	HLCN	1	15	Spring	HLCS	1
9	Support nut						
19	Spring pin	HLCO	1	GRIP			
Pad				22	Spring pin	HLCJ	1
6	Pad	HLCP	1	23	Grip	HLCG	1
11	Hex. hole bolt	HLCV	1				
12	Nylon nut		1				

1)When ordering, specify the rated capacity (ton) of item No. and H.
 (Example: Cam for HLC2H is HLCT2H.)

2)Periodic lubrication is required at pin and working portion.

REPLACEMENT PARTS AND ASSEMBLIES ■ HLC5H~10H HLC-WH(Wide Type)

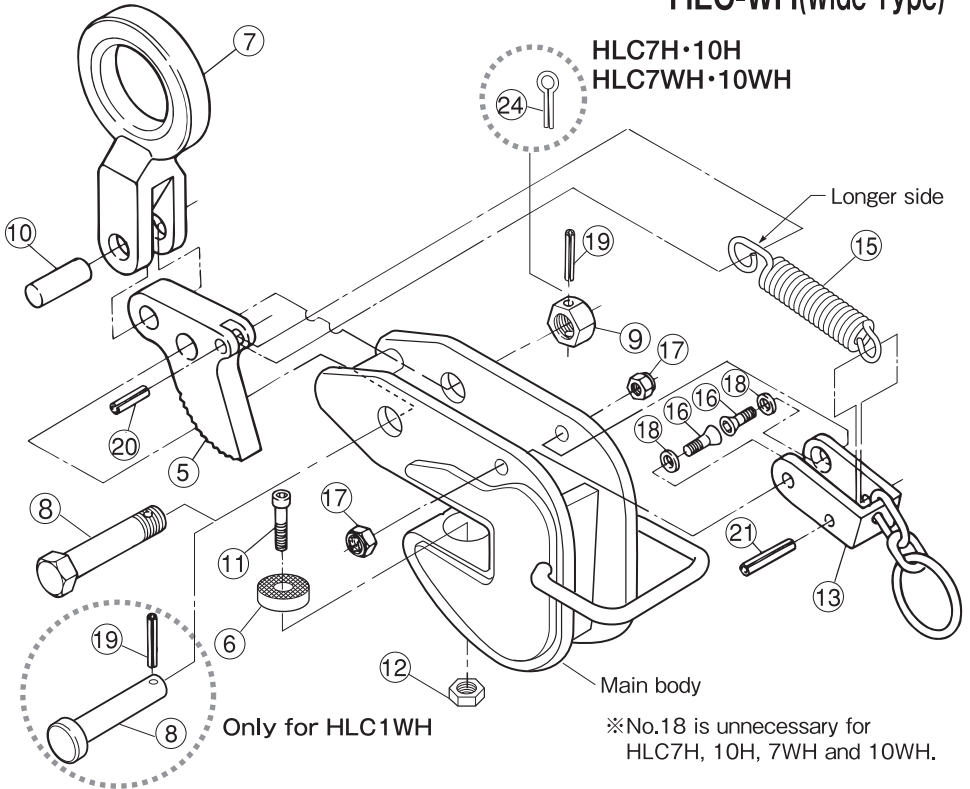

Part No.	Part Name	Item No.	Set Q'ty	Part No.	Part Name	Item No.	Set Q'ty
SHACKLE ASSEMBLY				PAD ASSEMBLY			
7	Shackle	HLCH	1	6	Pad	HLCP	1
10	Connection pin	HLCY	1	11	Hex. hole bolt	HLCV	1
CAM ASSEMBLY				12	Nylon nut		1
5	Cam	HLCT	1	HANDLE			
20	Spring pin	HLCR	1	13	U shaped handle	HLCU	1
8	Support pin	HLCN	1	21	Spring pin	HLCQ	1
8	Support bolt		1	16	Hex. hole bolt	HLCK	2
9	Support nut	1	17	U shaped nut	2		
19	Spring pin	HLCO	1	18	Collar	HLCC	2
24	Sprit pin	HLCW	1				
				15	Spring	HLCS	1

1)When ordering, specify the rated capacity (ton) of item No. and H or WH.

(Example: Cam for HLC1WH is HLCT1WH.)

2)Periodic lubrication is required at pin and working portion.

How to use

1. OPERATION METHOD

- (1) Please make sure to lock the U shaped handle and insert the load completely until it comes in contact with the deepest part of the jaw opening of main body.
- (2) When lifted off the ground, stop winding rope temporarily and re-start lifting operation after confirming the center of gravity and the clamping position for safety.
- (3) When detaching the load, release lock handle after losing rope.

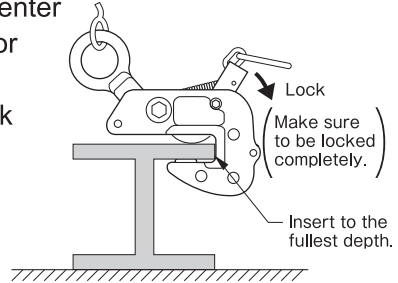

2. OPERATION PATTERNS

- (1) When lifting, please make sure to lock the handle and insert the load completely until it comes in contact with the deepest part of the jaw opening of main body.
- (2) Please make sure to lift at 2 or more points and use a balance whenever possible. Confirm that the length of two wire ropes is equal.

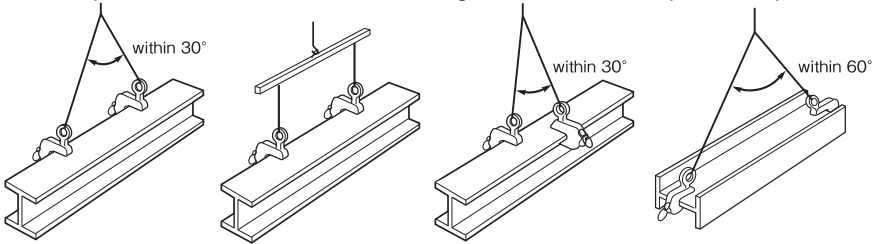

- (3) When lateral (horizontal) clamping steel plate, make sure to lift at four points. Confirm that the length of two wire ropes is equal.

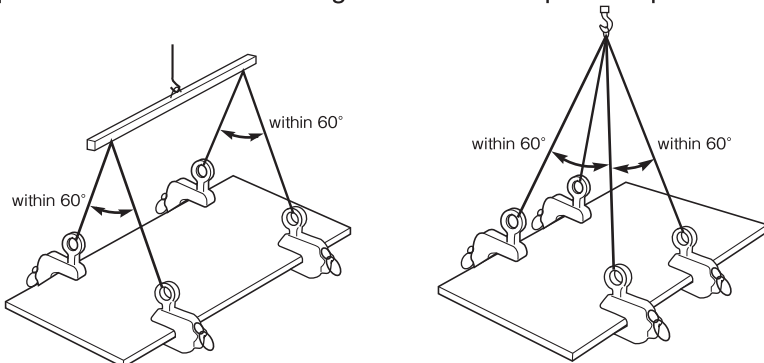

(4) Do not use for vertical lifting. Use vertical lifting clamp or screw cam clamp.

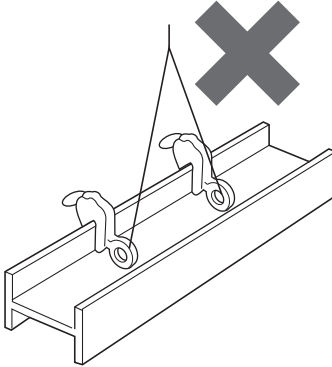

(5) Do not clamp steel plate side-way like the picture on the right. The clamping force is not applied to the load, which may result in load falling.

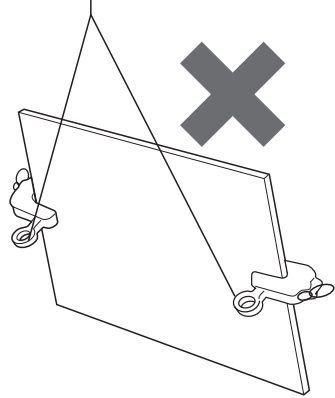

(6) When lifting the load obliquely, keep 0° to 45° for stability.

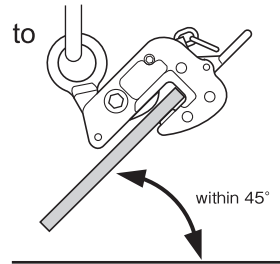

(7) Do not clamp curved steel plate. In this case, screw cam clamp (SCC type) is recommended.

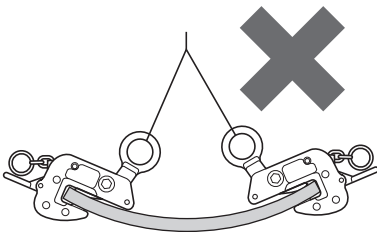

(8) Using for temporary turning over of steel structures is possible.

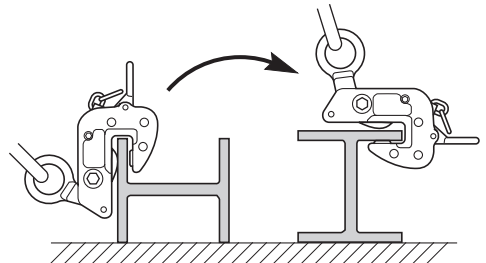

3.DISASSEMBLING AND ASSEMBLING

(1) Disassembling

A. Pad

After the cam is in the open lock state, insert a socket wrench that matches the nut into the rear part of the pad, insert a hexagon bar spanner into the bolt on the pad side, loosen the nut, and remove the pad.

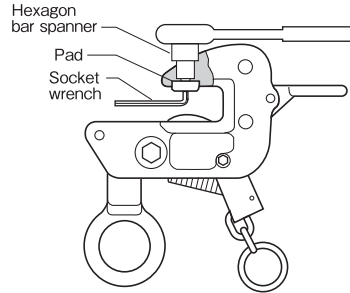

B. Cam and Shackle

1. Pull out spring pin for cam support bolt, loosen the nuts, and then pull out support bolts from the main body. (Make sure to keep the cam open.)

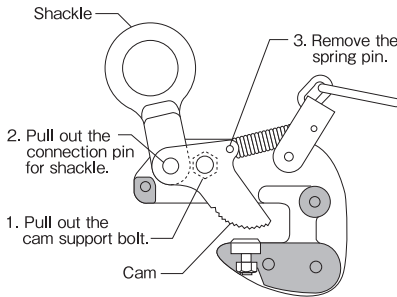

2. Pull out the shackle and the cam from the main body, pull out the shackle pin, and then remove the shackle from the cam.

3. Pull out spring pin for the cam spring, and remove the cam.

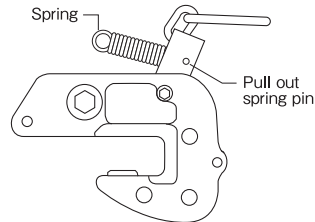

C. Spring

Spring can be disassembled by pulling out spring pin.

D. U shaped handle

Insert a hexagon bar spanner into the hex. hole disc bolt side, use offset wrench for the nut on the main body side, and then loosen the nuts and remove the bolts.

After pulling out the bolts on both sides, U shaped handle can be removed from main body.

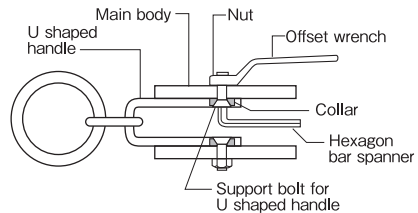

(2) Assembling

Perform the reverse procedure of disassembling.

■ CAUTION:

- ◆ Use within the rated capacity.
- ◆ Use within the clamp range.
- ◆ Do not use for any objects other than steel materials.
- ◆ Do not use for hard (30 HRC or higher) load.
- ◆ Lifting is not allowed for a load tapering down in upward direction.
- ◆ Do not apply shock to the load or lifting clamp.
- ◆ Do not lift more than one plate.
- ◆ Before using the product, be sure to check for clogging and wear of the teeth of the cam, screw and any other parts.
- ◆ Do not alter. Heating, modifying, etc. will significantly reduce the quality (strength).

■ OTHER:

- ◆ Inquiries for Repair Parts and Repair.
If repair parts or repairs are required, stop using this clamp and contact your distributor.

■ DAILY INSPECTION:



Conduct daily checks and maintenance to prevent the loss of safety and efficiency.

1. Check that there are no cracks at the body, cam, or wire rope holes.
2. Check if the movement and lubrication condition of each part are good.
3. **Check for wear, loss, or clogging of the teeth of the cam and screw.**
4. Refer to other inspection standards.

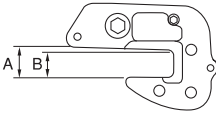
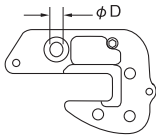
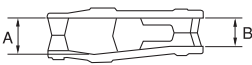
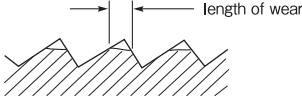
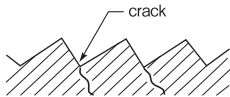
INSPECTION STANDARDS

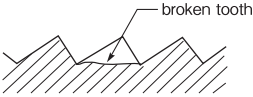
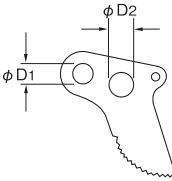
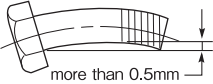
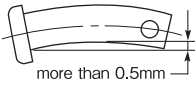
Item	Inspection method	Limit of use	Remedy																
<p style="text-align: center;">Main body</p>	<ul style="list-style-type: none"> ●Visually check or use color dyes to find cracks. ●Measure the jaw opening. ●Measure to find wear or deformation of hole of support bolts. ●Visually check or measure to find deformation or play. 	<ul style="list-style-type: none"> ●When found visually. ●When the difference between “A” and “B” for a depth of 100mm, exceeds 5mm (5%).  <ul style="list-style-type: none"> ●When the diameter of any part of circumference of any hole exceeds the respective size in the table below.  <table border="1" data-bbox="464 794 896 869"> <thead> <tr> <th>Rated capacity (ton)</th> <th>0.5</th> <th>1</th> <th>2</th> <th>3</th> <th>5</th> <th>7</th> <th>10</th> </tr> </thead> <tbody> <tr> <td>D(mm)</td> <td>14.5</td> <td>16.5</td> <td>20.5</td> <td>24.5</td> <td>30.5</td> <td>36.5</td> <td>42.5</td> </tr> </tbody> </table> <ul style="list-style-type: none"> ●When the difference of “A” and “B” exceeds 2mm. 	Rated capacity (ton)	0.5	1	2	3	5	7	10	D(mm)	14.5	16.5	20.5	24.5	30.5	36.5	42.5	Discard
	Rated capacity (ton)	0.5	1	2	3	5	7	10											
D(mm)	14.5	16.5	20.5	24.5	30.5	36.5	42.5												
<p style="text-align: center;">Cam & Pad</p>	<ul style="list-style-type: none"> ●Visually check and measure the degree of wear. ●Visually check or use color dyes to find cracks at the bottom cam teeth. 	<ul style="list-style-type: none"> ●When the length of wear exceeds 0.5mm.  <ul style="list-style-type: none"> ●When found visually. 	Replace																

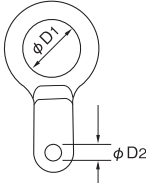
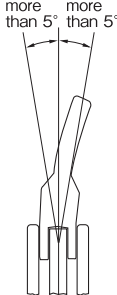
Item	Inspection method	Limit of use	Remedy																								
<h3>Cam & Pad</h3>	<ul style="list-style-type: none"> ●Visually check for broken teeth. ●Measure wear or deformation of holes of support bolts. ●Visually check or measure wear or deformation of each parts. 	<ul style="list-style-type: none"> ●When any broken tooth is found.  <ul style="list-style-type: none"> ●When the diameter of any part of circumference of any hole exceeds the respective size in the table below.  <table border="1" data-bbox="538 603 949 699" style="width: 100%; border-collapse: collapse; text-align: center;"> <thead> <tr> <th>Rated capacity (ton)</th> <th>0.5</th> <th>1</th> <th>2</th> <th>3</th> <th>5</th> <th>7</th> <th>10</th> </tr> </thead> <tbody> <tr> <td>D1 (mm)</td> <td>11.5</td> <td>13.5</td> <td>16.5</td> <td>20.5</td> <td>25.5</td> <td>30.5</td> <td>36.5</td> </tr> <tr> <td>D2 (mm)</td> <td>14.5</td> <td>16.5</td> <td>20.5</td> <td>24.5</td> <td>30.5</td> <td>36.5</td> <td>42.5</td> </tr> </tbody> </table> <ul style="list-style-type: none"> ●When found visually. 	Rated capacity (ton)	0.5	1	2	3	5	7	10	D1 (mm)	11.5	13.5	16.5	20.5	25.5	30.5	36.5	D2 (mm)	14.5	16.5	20.5	24.5	30.5	36.5	42.5	<p>Replace</p>
Rated capacity (ton)	0.5	1	2	3	5	7	10																				
D1 (mm)	11.5	13.5	16.5	20.5	25.5	30.5	36.5																				
D2 (mm)	14.5	16.5	20.5	24.5	30.5	36.5	42.5																				
<h3>Support Bolt, Support Pin, Support Nut & Spring Pin for Cam</h3>	<ul style="list-style-type: none"> ●Measure wear of the bolt shaft. ●Visually check or use color dyes to find cracks. ●Visually check or measure deformation. ●Visually check the installation state of nuts and spring pins. ●Visually check the installation state of nuts. ●Visually check deformation of spring parts. 	<ul style="list-style-type: none"> ●When the diameter of any part of circumference of any hole is less than the respective size in the table below. <table border="1" data-bbox="524 890 953 959" style="width: 100%; border-collapse: collapse; text-align: center;"> <thead> <tr> <th>Rated capacity (ton)</th> <th>0.5</th> <th>1</th> <th>2</th> <th>3</th> <th>5</th> <th>7</th> <th>10</th> </tr> </thead> <tbody> <tr> <td>Diameter(mm)</td> <td>13.5</td> <td>15.5</td> <td>19.5</td> <td>23.5</td> <td>29.5</td> <td>35.5</td> <td>41.5</td> </tr> </tbody> </table> <ul style="list-style-type: none"> ●When found visually. ●When the deformation exceeds 0.5mm.   <ul style="list-style-type: none"> ●When found any damage, loose or coming off. ●When the spring pin is cut or removed, and the nut is loose. ●When the hole of pins is damaged, and the nut cannot be installed. 	Rated capacity (ton)	0.5	1	2	3	5	7	10	Diameter(mm)	13.5	15.5	19.5	23.5	29.5	35.5	41.5	<p>Replace</p>								
Rated capacity (ton)	0.5	1	2	3	5	7	10																				
Diameter(mm)	13.5	15.5	19.5	23.5	29.5	35.5	41.5																				

Item	Inspection method	Limit of use	Remedy																								
Shackle	<ul style="list-style-type: none"> ●Visually check or use color dyes to find cracks. ●Measure wear or deformation of shackle hole and pin hole. 	<ul style="list-style-type: none"> ●When found visually. ●When the diameter of any part of circumference of any hole exceeds the respective size in the table below. <table border="1" data-bbox="460 384 888 480"> <thead> <tr> <th>Rated capacity (ton)</th> <th>0.5</th> <th>1</th> <th>2</th> <th>3</th> <th>5</th> <th>7</th> <th>10</th> </tr> </thead> <tbody> <tr> <td>D1 (mm)</td> <td>41.0</td> <td>51.0</td> <td>61.0</td> <td>71.0</td> <td>81.0</td> <td>81.0</td> <td>81.0</td> </tr> <tr> <td>D2 (mm)</td> <td>11.5</td> <td>13.5</td> <td>16.5</td> <td>20.5</td> <td>25.5</td> <td>30.5</td> <td>36.5</td> </tr> </tbody> </table> 	Rated capacity (ton)	0.5	1	2	3	5	7	10	D1 (mm)	41.0	51.0	61.0	71.0	81.0	81.0	81.0	D2 (mm)	11.5	13.5	16.5	20.5	25.5	30.5	36.5	Replace
	Rated capacity (ton)	0.5	1	2	3	5	7	10																			
	D1 (mm)	41.0	51.0	61.0	71.0	81.0	81.0	81.0																			
	D2 (mm)	11.5	13.5	16.5	20.5	25.5	30.5	36.5																			
<ul style="list-style-type: none"> ●Visually check or measure the degree of deformation. 	<ul style="list-style-type: none"> ●When the deformation exceeds more than 5° from the center line of main body. 																										
<ul style="list-style-type: none"> ●Measure wear or deformation of groove part. 	<ul style="list-style-type: none"> ●When the diameter of any part of groove part exceeds the respective size in the table below. <table border="1" data-bbox="460 1190 888 1262"> <thead> <tr> <th>Rated capacity (ton)</th> <th>0.5</th> <th>1</th> <th>2</th> <th>3</th> <th>5</th> <th>7</th> <th>10</th> </tr> </thead> <tbody> <tr> <td>A (mm)</td> <td>14.0</td> <td>18.0</td> <td>20.0</td> <td>22.0</td> <td>24.0</td> <td>26.0</td> <td>33.0</td> </tr> </tbody> </table> 	Rated capacity (ton)	0.5	1	2	3	5	7	10	A (mm)	14.0	18.0	20.0	22.0	24.0	26.0	33.0										
Rated capacity (ton)	0.5	1	2	3	5	7	10																				
A (mm)	14.0	18.0	20.0	22.0	24.0	26.0	33.0																				

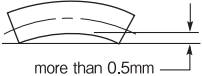
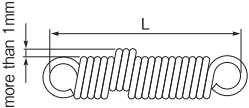
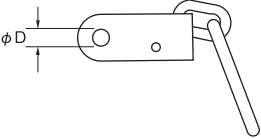
Item	Inspection method	Limit of use	Remedy																		
Connection Pin for Shackle	<ul style="list-style-type: none"> ●Measure wear of shaft. ●Visually check or measure to find deformation. 	<ul style="list-style-type: none"> ●When the diameter of any part of circumference of the shaft is less than the size in the table below. <table border="1" data-bbox="512 272 941 344"> <tr> <td>Rated capacity (ton)</td> <td>0.5</td> <td>1</td> <td>2</td> <td>3</td> <td>5</td> <td>7</td> <td>10</td> </tr> <tr> <td>Diameter(mm)</td> <td>10.5</td> <td>12.5</td> <td>15.5</td> <td>19.5</td> <td>24.5</td> <td>29.5</td> <td>35.5</td> </tr> </table> <ul style="list-style-type: none"> ●When the deformation exceeds 0.5mm. 	Rated capacity (ton)	0.5	1	2	3	5	7	10	Diameter(mm)	10.5	12.5	15.5	19.5	24.5	29.5	35.5	Replace		
Rated capacity (ton)	0.5	1	2	3	5	7	10														
Diameter(mm)	10.5	12.5	15.5	19.5	24.5	29.5	35.5														
Spring	<ul style="list-style-type: none"> ●Visually check whether a constant initial load always works when U shaped handle is locked. ●Visually check to find cracks or deformation on both hook side. ●Visually check or measure to find deformation or extension. 	<ul style="list-style-type: none"> ●When there is no normal repulsive force due to deformation, etc., and when the U shaped handle is locked with the clamping dimension 0, there is a clearance of 1mm or more at the gripping part due to the self-weight of the shackle and cam. ●When the inner diameter of the hook is remarkably turned wear or there is a risk that it may come off from the spring pin due to deformation, etc. ●When the deformation exceeds 1mm, or the diameter of length of the spring exceeds the size in the table below.  <table border="1" data-bbox="501 978 947 1050"> <tr> <td>Rated capacity (ton)</td> <td>0.5</td> <td>1</td> <td>2</td> <td>3</td> <td>5</td> <td>5W</td> <td>7</td> <td>10</td> </tr> <tr> <td>L (mm)</td> <td>72.0</td> <td>76.0</td> <td>88.5</td> <td>100.5</td> <td>114</td> <td>136.5</td> <td>194</td> <td>204</td> </tr> </table>	Rated capacity (ton)	0.5	1	2	3	5	5W	7	10	L (mm)	72.0	76.0	88.5	100.5	114	136.5	194	204	Replace
Rated capacity (ton)	0.5	1	2	3	5	5W	7	10													
L (mm)	72.0	76.0	88.5	100.5	114	136.5	194	204													
U shaped handle	<ul style="list-style-type: none"> ●Measure wear or deformation of holes of bolts. ●Visually check deformation of each parts. 	<ul style="list-style-type: none"> ●When the diameter of any part of circumference of any hole exceeds the respective size in the table below. <table border="1" data-bbox="512 1177 941 1249"> <tr> <td>Rated capacity (ton)</td> <td>0.5</td> <td>1</td> <td>2</td> <td>3</td> <td>5</td> <td>7</td> <td>10</td> </tr> <tr> <td>D (mm)</td> <td>12.7</td> <td>12.7</td> <td>16.7</td> <td>16.7</td> <td>16.7</td> <td>13.0</td> <td>13.0</td> </tr> </table>  <ul style="list-style-type: none"> ●When the movement of U shaped handle is not smooth. 	Rated capacity (ton)	0.5	1	2	3	5	7	10	D (mm)	12.7	12.7	16.7	16.7	16.7	13.0	13.0	Replace		
Rated capacity (ton)	0.5	1	2	3	5	7	10														
D (mm)	12.7	12.7	16.7	16.7	16.7	13.0	13.0														

Item	Inspection method	Limit of use	Remedy																
Bolt, Collar, Nut for U shaped handle	<ul style="list-style-type: none"> ●Measure wear of the shaft of bolt and collar. ●Visually check to find deformation. ●Visually check the installation state of nuts. 	<ul style="list-style-type: none"> ●When the diameter of any part of circumference of shaft is less than the respective size in the table below. <table border="1" data-bbox="453 247 882 319" style="width: 100%; border-collapse: collapse; text-align: center;"> <tr> <td style="border: none;">Rated capacity (ton)</td> <td>0.5</td> <td>1</td> <td>2</td> <td>3</td> <td>5</td> <td>7</td> <td>10</td> </tr> <tr> <td style="border: none;">Diameter(mm)</td> <td>7.5</td> <td>7.5</td> <td>9.5</td> <td>9.5</td> <td>9.5</td> <td>11.5</td> <td>11.5</td> </tr> </table> <ul style="list-style-type: none"> ●When the movement of U shaped handle is not smooth. ●When found any damage, loose or coming off. 	Rated capacity (ton)	0.5	1	2	3	5	7	10	Diameter(mm)	7.5	7.5	9.5	9.5	9.5	11.5	11.5	Replace
Rated capacity (ton)	0.5	1	2	3	5	7	10												
Diameter(mm)	7.5	7.5	9.5	9.5	9.5	11.5	11.5												

